

Dual NPN Small Signal Transistor

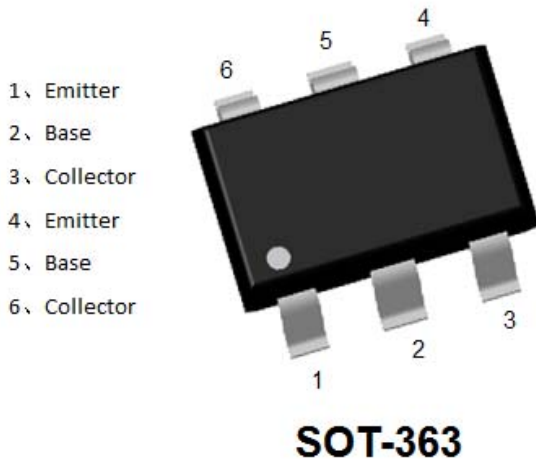

Features

- Epoxy meets UL-94 V-0 flammability rating
- Surface mount package ideally Suited for Automatic Insertion
- Moisture Sensitivity Level 1
- Part no. with suffix “Q” means AEC-Q101 qualified

Mechanical Data

- **Package:** SOT-363
- **Terminals:** Tin plated leads, solderable per J-STD-002 and JESD22-B102
- **Marking:** 1C

■Equivalent circuit

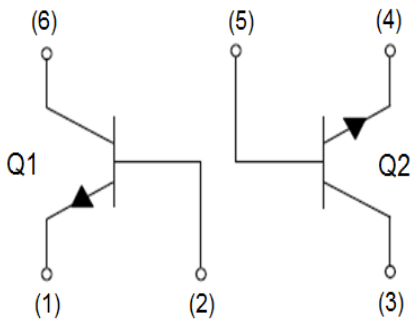



BC847BSQ

■Maximum Ratings (Ta=25°C Unless otherwise specified)

Q1&Q2-NPN

Item	Symbol	Unit	Conditions	Value
Collector-Base Voltage	V_{CBO}	V	$I_C=10\mu A, I_E=0$	50
Collector-Emitter Voltage	V_{CEO}	V	$I_C=10mA, I_B=0$	45
Emitter-Base Voltage	V_{EBO}	V	$I_E=10\mu A, I_C=0$	6
Collector Current -Continuous	I_C	mA		100
Total Device Dissipation (*)	P_C	mW		200
Thermal Resistance Junction to Ambient (*)	R_{thJA}	K/W		625
Junction Temperature	T_j	°C		-55 to +150
Storage Temperature	TSTG	°C		-55 to +150

(*) Device mounted on FR-4 PCB 1.0 x 1.0 x 0.06 inch.

■Electrical Characteristics (Ta=25°C unless otherwise specified)

Q1&Q2-NPN

Item	Symbol	Unit	Conditions	Min	TYP	Max
Collector-base breakdown voltage	$V_{(BR)CBO}$	V	$I_C=10\mu A, I_E=0$	50		
Collector-emitter breakdown voltage	$V_{(BR)CEO}$	V	$I_C=10mA, I_B=0$	45		
Emitter-base breakdown voltage	$V_{(BR)EBO}$	V	$I_E=10\mu A, I_C=0$	6		
Collector cut-off current	I_{CBO}	nA	$V_{CB}=30V, I_E=0$			100
Collector cut-off current	I_{EBO}	nA	$V_{EB}=5V, I_C=0$			100
DC current gain	h_{FE}		$V_{CE}=5V, I_C=2mA$	200		450
Collector-emitter saturation voltage	$V_{CE(sat)}$	V	$I_C=10mA, I_B=0.5mA$			0.25
			$I_C=100mA, I_B=5mA$			0.65
Base-emitter saturation voltage	$V_{BE(sat)}$	V	$I_C=10mA, I_B=0.5mA$			1.05
			$I_C=100mA, I_B=5mA$			1.1
Base-emitter Voltage	V_{BE}	V	$V_{CE}=5V, I_C=2mA$	0.58	0.665	0.7
Transition frequency	F_t	MHz	$V_{CE}=5V, I_C=10mA, f=30MHz$	150		

■ Ordering Information (Example)

PREFERRED P/N	PACKING CODE	UNIT WEIGHT(g)	MINIMUM PACKAGE(pcs)	INNER BOX QUANTITY(pcs)	OUTER CARTON QUANTITY(pcs)	DELIVERY MODE
BC847BSQ	F2	Approximate 0.007g	3000	30000	120000	7" reel



■ Characteristics (Typical)
Q1&Q2-NPN

Fig. 1-Static Characteristic

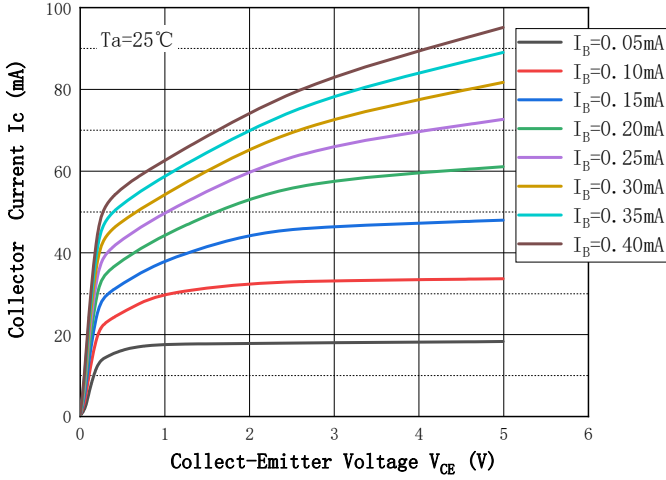

Fig. 2 - DC Current Gian

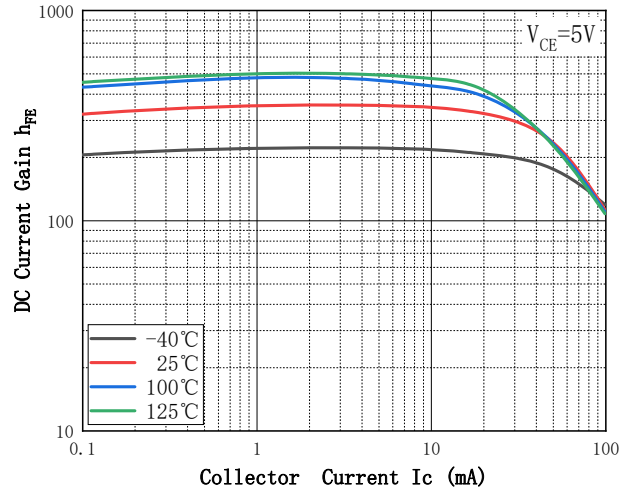

Fig. 3 - Collect-Emittor Saturation Voltage

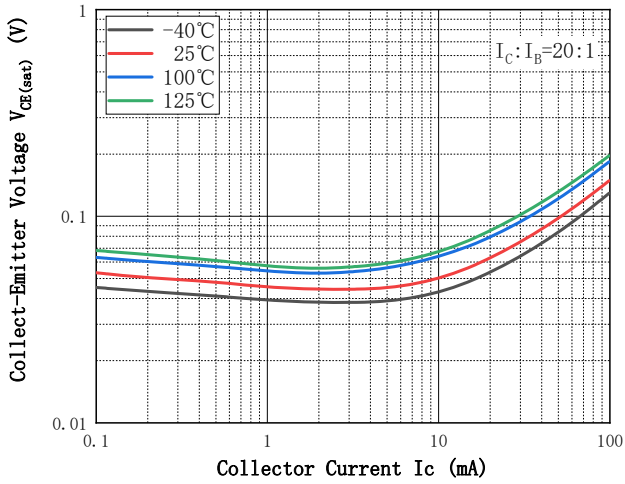

Fig. 4 - Base-Emittor Voltage

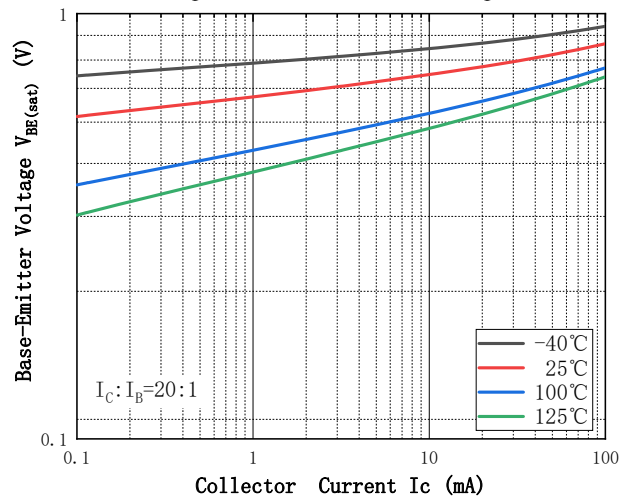

Fig. 5 - Base-Emittor On Voltage

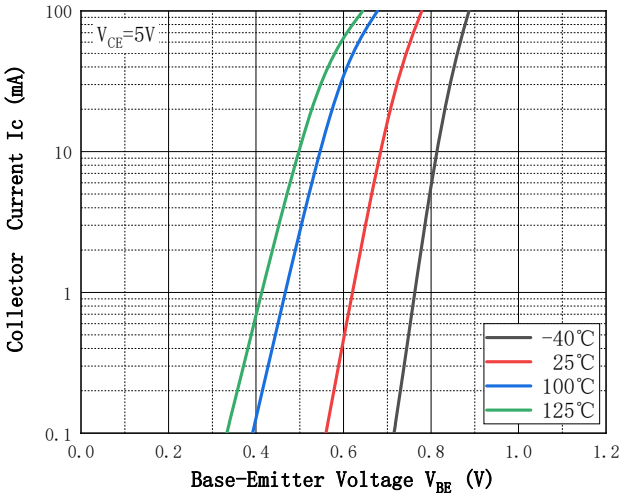
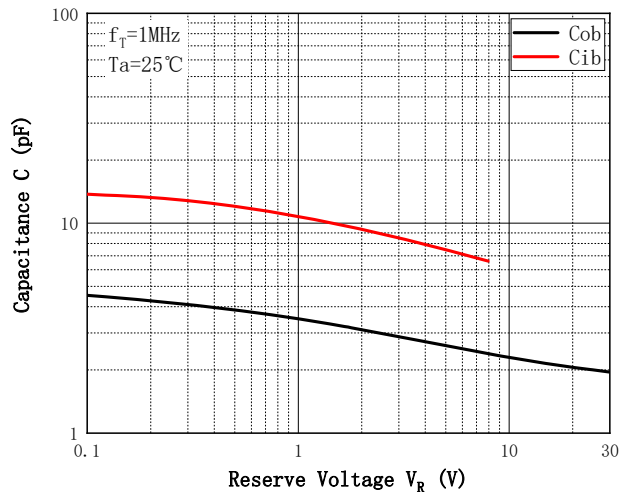

Fig. 6 - Cob/Cib— V_{CB}/V_{EB}





BC847BSQ

■SOT-363 Package Outline Dimensions

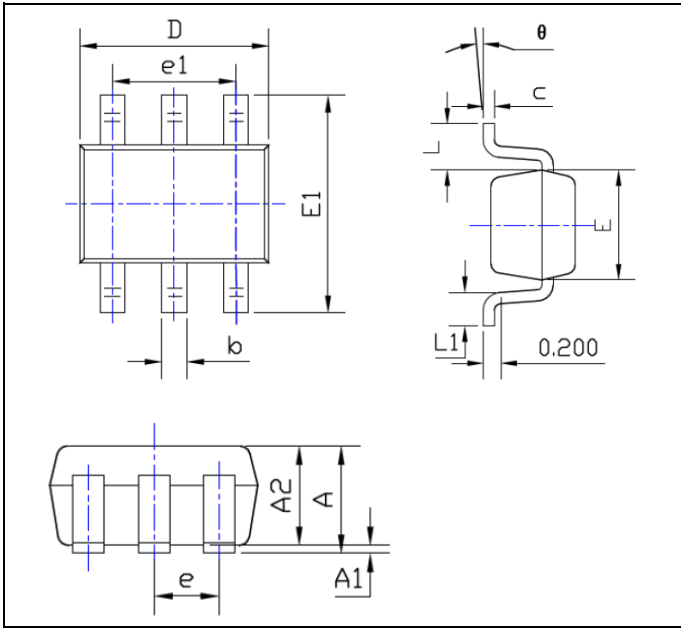

SYMBOL	DIMENSIONS			
	INCHES		Millimeter	
	MIN.	MAX.	MIN.	MAX.
A	0.035	0.043	0.900	1.100
A1	0.000	0.004	0.000	0.100
A2	0.035	0.039	0.900	1.000
b	0.006	0.014	0.150	0.350
c	0.004	0.010	0.100	0.250
D	0.071	0.087	1.800	2.200
E	0.045	0.053	1.150	1.350
E1	0.085	0.096	2.150	2.450
e	0.026TYP		0.650TYP	
e1	0.047	0.055	1.200	1.400
L	0.021REF		0.525REF	
L1	0.010	0.018	0.260	0.460
θ	0°	8°	0°	8°

■SOT-363 Suggested Pad Layout

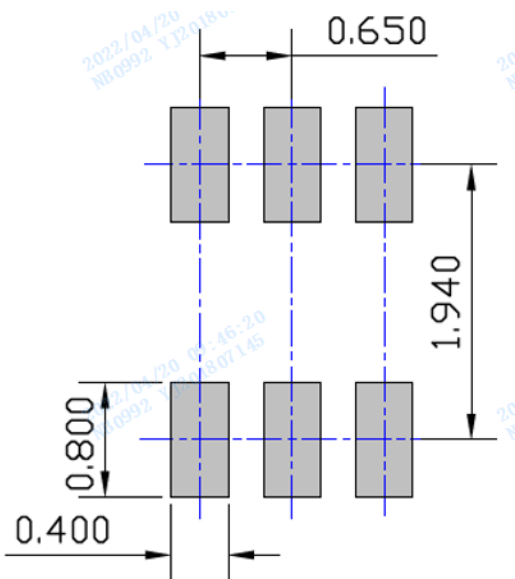

Unit: mm

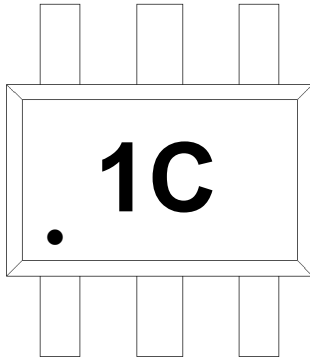
■ Marking Information**Note:**

1. All marking is at middle of the product body
2. All marking is in laser marking
3. 1C is Marking Code
4. Body color: Black



BC847BSQ

Disclaimer

The information presented in this document is for reference only. Yangzhou Yangjie Electronic Technology Co., Ltd. reserves the right to make changes without notice for the specification of the products displayed herein to improve reliability, function or design or otherwise.

The product listed herein is designed to be used with automotive electronics, are not designed for use in medical, life-saving, lifesustaining, or military. Yangjie or anyone on its behalf, assumes no responsibility or liability for any damages resulting from such improper use of sale.

This publication supersedes & replaces all information previously supplied. For additional information, please visit our website [http:// www.21yangjie.com](http://www.21yangjie.com) , or consult your nearest Yangjie's sales office for further assistance.