

P-Channel Enhancement Mode Field Effect Transistor

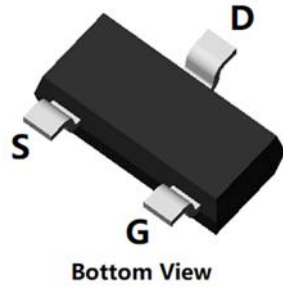

SOT-23

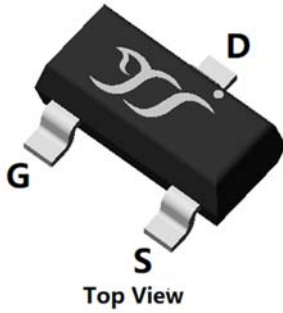
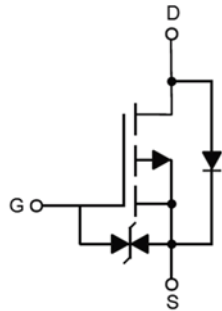

Product Summary

- V_{DS} -20V
- I_D -2.4A
- $R_{DS(ON)}$ (at $V_{GS}=-4.5V$) <95mohm
- ESD Protected Up to 2.0KV (HBM)

General Description

- Trench Power LV MOSFET technology
- High Power and Current handling capability
- Low Gate Charge
- Part no. with suffix "Q" means AEC-Q101 qualified
- Moisture Sensitivity Level 1

Applications

- PWM applications
- Power management
- Load switch

■ Absolute Maximum Ratings ($T_A=25^\circ C$ unless otherwise noted)

Parameter		Symbol	Limit	Unit
Drain-source Voltage		V_{DS}	-20	V
Gate-source Voltage		V_{GS}	± 12	V
Drain Current	$T_A=25^\circ C$	I_D	-2.4	A
	$T_A=100^\circ C$		-1.5	
Total Power Dissipation	$T_A=25^\circ C$	P_D	890	mW
	$T_A=100^\circ C$		350	
Pulsed Drain Current ^A		I_{DM}	-10	A
Junction and Storage Temperature Range		T_J, T_{STG}	-55~+150	$^\circ C$

■ Thermal resistance

Parameter		Symbol	Typ	Max	Units
Thermal Resistance Junction-to-Ambient ^B	Steady-State	$R_{\theta JA}$	115	140	$^\circ C/W$

■ Ordering Information (Example)

PREFERRED P/N	PACKING CODE	Marking	MINIMUM PACKAGE(pcs)	INNER BOX QUANTITY(pcs)	OUTER CARTON QUANTITY(pcs)	DELIVERY MODE
YJL2301HQ	F2	2301H.	3000	30000	120000	7" reel



YJL2301HQ

■ Electrical Characteristics (T_J=25°C unless otherwise noted)

Parameter	Symbol	Conditions	Min	Typ	Max	Units
Static Parameter						
Drain-Source Breakdown Voltage	BV _{DSS}	V _{GS} =0V, I _D =-250μA	-20			V
Zero Gate Voltage Drain Current	I _{DSS}	V _{DS} =-20V, V _{GS} =0V			-1	μA
Gate-Body Leakage Current	I _{GSS}	V _{GS} =±12V, V _{DS} =0V			±10	μA
Gate Threshold Voltage	V _{GS(th)}	V _{DS} = V _{GS} , I _D =-250μA	-0.5	-1	-1.5	V
Static Drain-Source On-Resistance	R _{DS(ON)}	V _{GS} =-4.5V, I _D =-2.4A		70	95	mΩ
Diode Forward Voltage	V _{SD}	I _S =-1A, V _{GS} =0V			-1.2	V
Dynamic Parameters						
Gate resistance	R _G	f=1MHz, Open drain		15		Ω
Input Capacitance	C _{iss}	V _{DS} =-10V, V _{GS} =0V, f=1MHZ		380		pF
Output Capacitance	C _{oss}			81		
Reverse Transfer Capacitance	C _{rss}			60		
Switching Parameters						
Total Gate Charge	Q _g	V _{GS} =-4.5V, V _{DS} =-10V, I _D =-2.4A		5.3		nC
Gate-Source Charge	Q _{gs}			1.6		
Gate-Drain Charge	Q _{gd}			1.7		
Reverse Recovery Charge	Q _{rr}	I _F =-1A, di/dt=40A/us		1.71		ns
Reverse Recovery Time	t _{rr}			13.5		
Turn-on Delay Time	t _{D(on)}	V _{GS} =-4.5V, V _{DS} =-10V, I _D =-1A R _{GEN} =3Ω		8.2		ns
Turn-on Rise Time	t _r			23		
Turn-off Delay Time	t _{D(off)}			22.8		
Turn-off fall Time	t _f			25.6		

A. Repetitive rating; pulse width limited by max. junction temperature.

B. The value of R_{θJA} is measured with the device mounted on 1 in² FR-4 board with 2oz. Copper, in the still air environment with T_A =25°C. The maximum allowed junction temperature of 150°C. The value in any given application depends on the user's specific board design.



Typical Performance Characteristics

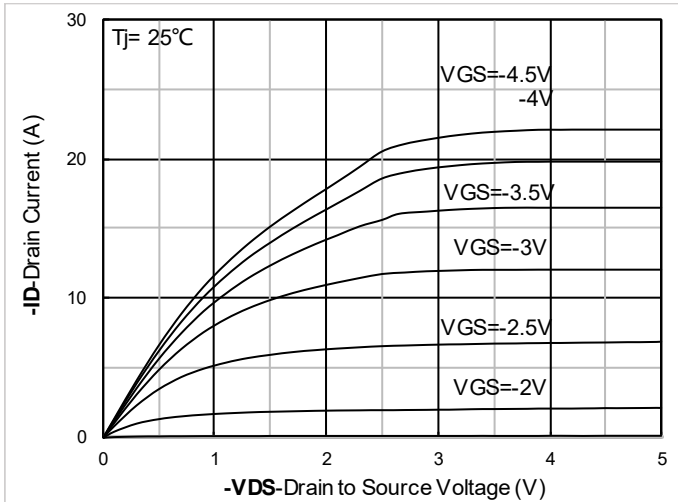

Figure1. Output Characteristics

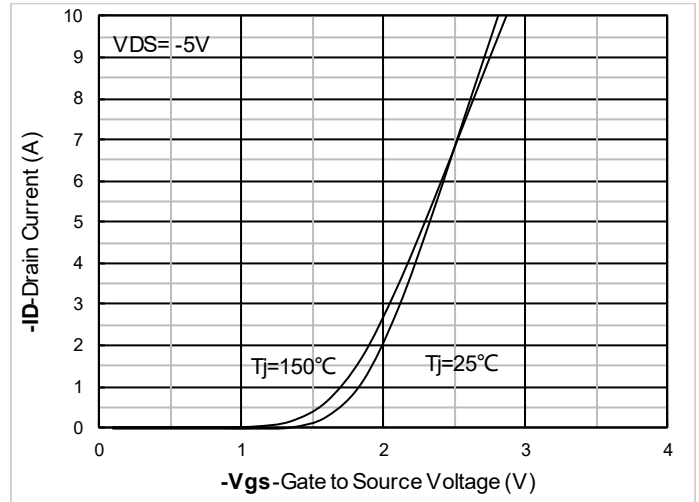

Figure2. Transfer Characteristics

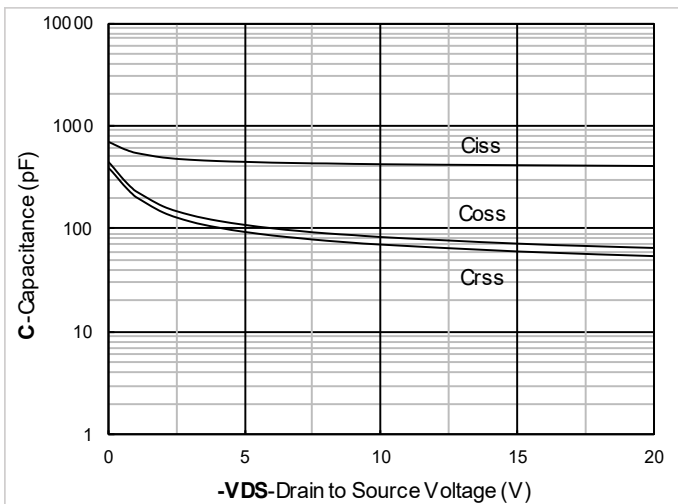

Figure3. Capacitance Characteristics

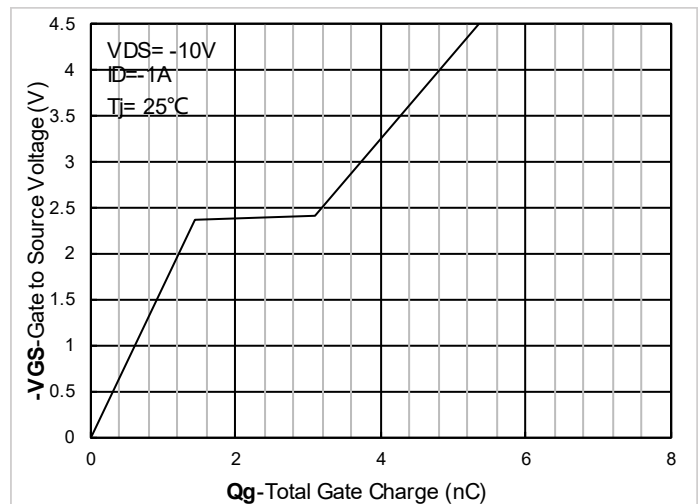

Figure4. Gate Charge

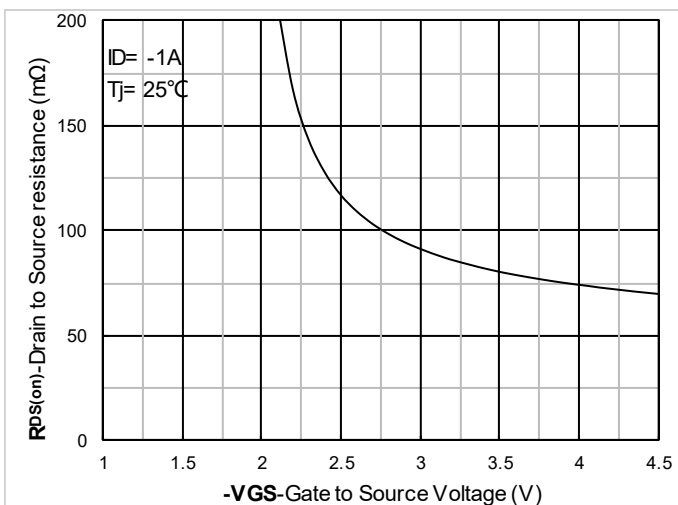

Figure5. On-Resistance vs Gate to Source Voltage

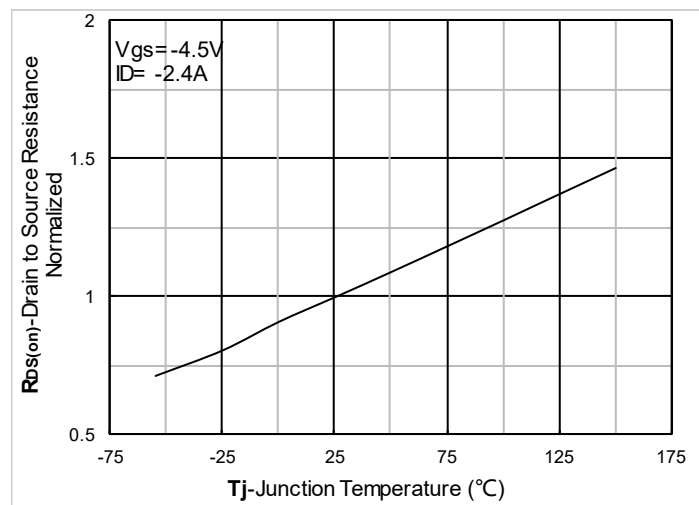

Figure6. Normalized On-Resistance



YJL2301HQ

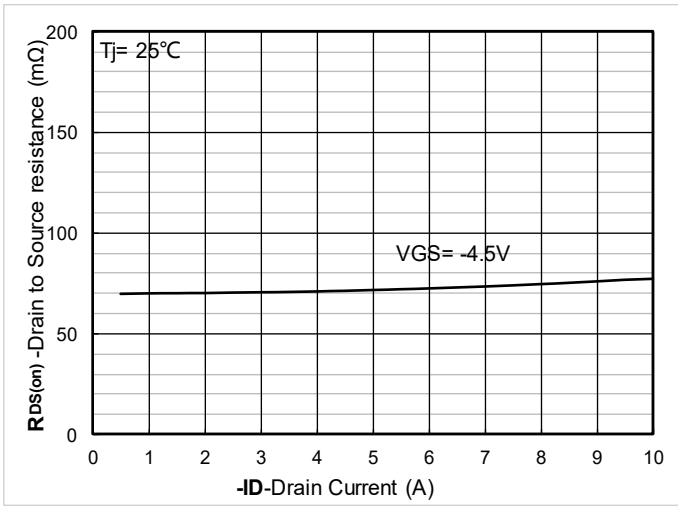

Figure 7. $R_{DS(on)}$ VS Drain Current

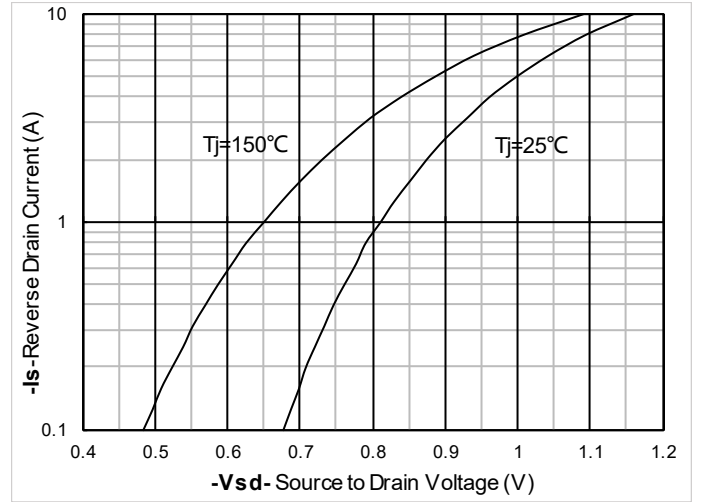

Figure 8. Forward characteristics of reverse diode

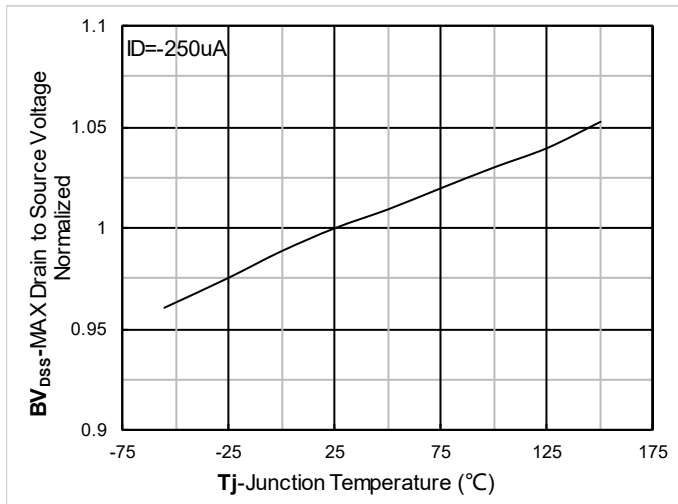

Figure 9. Normalized breakdown voltage

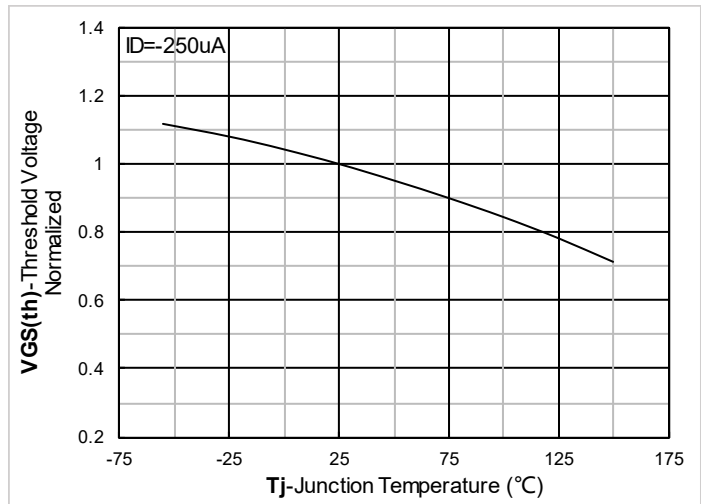

Figure 10. Normalized Threshold voltage

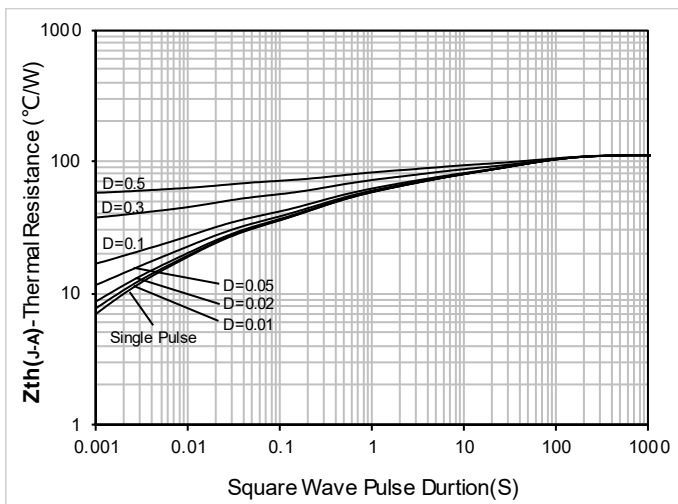

Figure 11. Maximum Transient Thermal Impedance

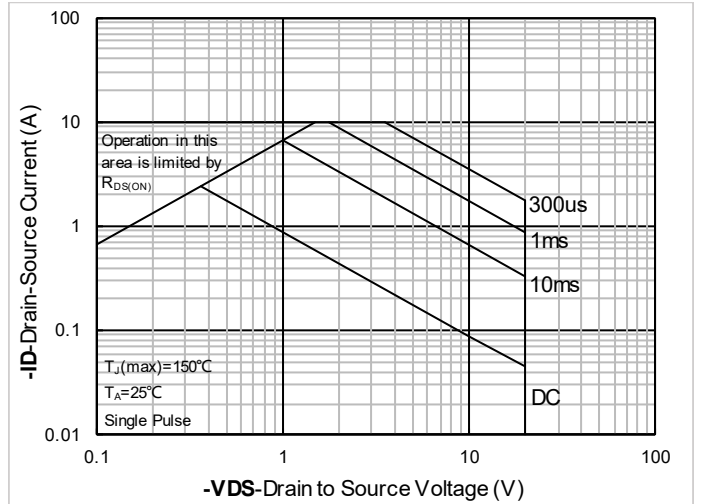
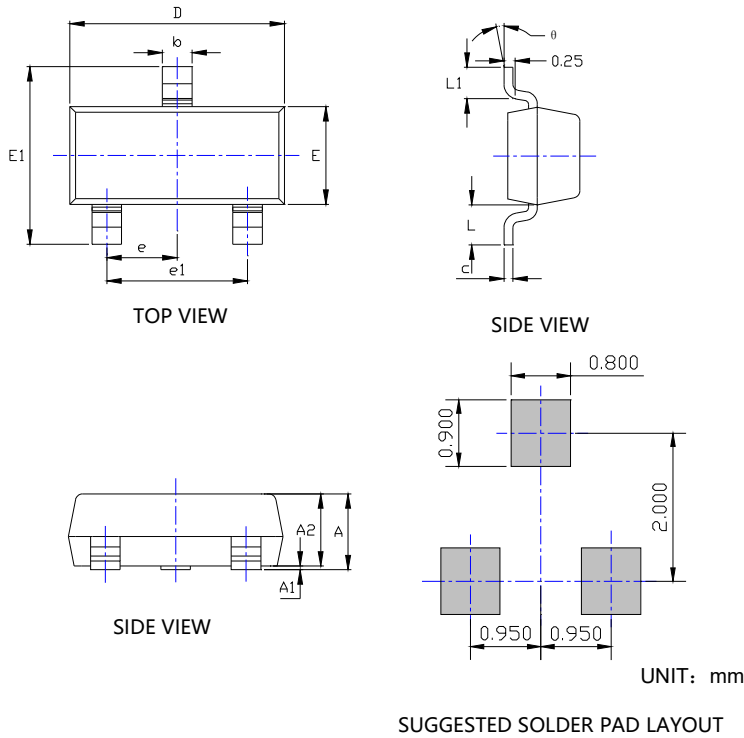

Figure 12. Safe Operation Area



YJL2301HQ

■ SOT-23 Package Outline Dimensions



SYMBOL	DIMENSIONS			
	INCHES		Millimeter	
	MIN.	MAX.	MIN.	MAX.
A	0.035	0.045	0.900	1.150
A1	0.000	0.004	0.000	0.100
A2	0.035	0.041	0.900	1.050
b	0.012	0.020	0.300	0.500
c	0.004	0.008	0.100	0.200
D	0.110	0.118	2.800	3.000
E	0.047	0.055	1.200	1.400
E1	0.089	0.100	2.250	2.550
e	0.037TYP		0.950TYP	
e1	0.071	0.079	1.800	2.000
L	0.022REF		0.550REF	
L1	0.012	0.020	0.300	0.500
θ	0°	8°	0°	8°

NOTE:
 1.PACKAGE BODY SIZES EXCLUDE MOLD FLASH AND GATE BURRS.
 2.TOLERANCE 0.1mm UNLESS OTHERWISE SPECIFIED.
 3.THE PAD LAYOUT IS FOR REFERENCE PURPOSES ONLY.

■ Marking Information

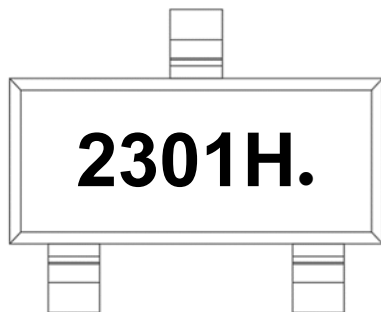

- Note:
1. All marking is at middle of the product body
 2. All marking is in laser marking
 3. 2301H is Marking Code
 4. Body color: Black



Disclaimer

The information presented in this document is for reference only. Yangzhou Yangjie Electronic Technology Co., Ltd. reserves the right to make changes without notice for the specification of the products displayed herein to improve reliability, function or design or otherwise.

The product listed herein is designed to be used with automotive electronics, are not designed for use in medical, life-saving, lifesustaining, or military, Yangjie or anyone on its behalf, assumes no responsibility or liability for any damages resulting from such improper use of sale.

This publication supersedes & replaces all information previously supplied. For additional information, please visit our website [http:// www.21yangjie.com](http://www.21yangjie.com) , or consult your nearest Yangjie's sales office for further assistance.